

Instructions



Blown SW5

Samuel Wilkinson

2018

Congratulations with your new Blown lamp, designed in 2018 by Samuel Wilkinson. We hope you will enjoy using this product and follow these instructions to ensure correct installation. If you have any questions or comments, please do not hesitate to contact us by mail on:

info@andtradition.com

Blown SW5 Samuel Wilkinson 2018

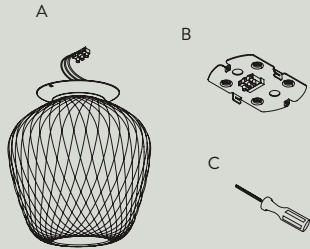

Please read these instructions carefully and retain them for future reference to ensure that the product is used correctly. For your own safety, please study each step of this instruction manual first. Tradition is not responsible for any faults or damages caused by not following these instructions correctly. Do not modify this product in any way.

Contents

- A Shade
- B Metal ceiling bracket
- C Hex screwdriver

Tools needed

- Bulb type E27
- Flat head screwdriver (for connecting the wires)

Safety precautions

- Dispose of plastic bag from packaging and do not allow children to play with it.
- Keep product well out of children's reach.
- The lamp is only intended for interior use.
- Consult a professionally qualified electrician if in any doubt.
- Disconnect the electricity supply at the fuse box, before commencing work.

Cleaning instructions

- Wipe surface of the glass shade with a soft, damp sponge or cloth, and wipe immediately after with a dry cloth.
- Do not use any abrasive cleaning tools such as steel wool, scouring sponges or stiff brushes.
- Never use strong cleaning agents such as white spirit, turpentine, household glass cleaner or cellulose thinners.
- Only wipe the inside of the shade with a soft, damp cloth or feather duster.

For indoor use only
E27 maximum 60W
Bulb not included

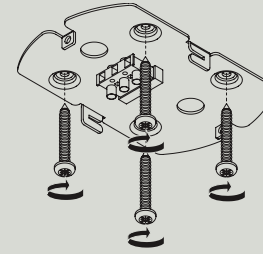

Step 1

Ensure that the power supply is turned off, locate the supply cable and pass it through one of the holes in the metal bracket (B).

Mount the metal bracket securely in the ceiling with wall plugs and screws appropriate for the type of ceiling. Make sure the electrical cable is passing freely through the hole in the metal plate.

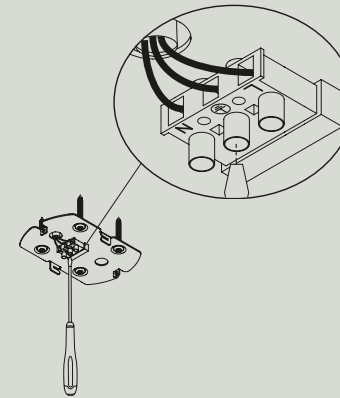

Step 2

Connecting the wires

Cut off the excess cord so that a minimum of 80 mm cord is left to reconnect to the cable connector. Peel back the outer cable using to expose 30 mm of the blue and brown inner cables. Strip the inner cable to expose 5 mm of wire. Connect the brown supply wire (L) to the terminal of the connector marked 'L'.

Connect the blue supply wire (N) to the terminal of the connector marked 'N'.

Connect green supply wire (ground) to the terminal of the connector with the symbol \oplus .

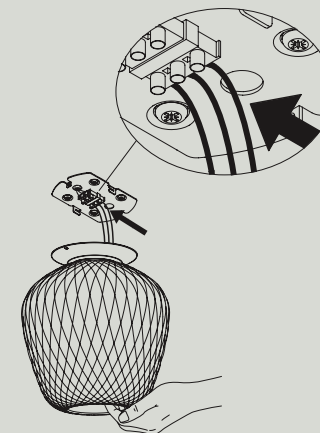

Step 3

Hold the shade (A) carefully underneath the ceiling bracket and connect the terminal plug from the lamp to the terminal plug in the wall bracket. Make sure the terminal plugs are firmly connected.

CE \oplus ∇ IP20 \times

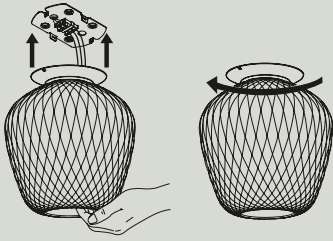
**Step 4**

Mount the lamp by fitting lamp base to ceiling bracket (B) and afterwards twisting the lamp clockwise to lock. Make sure that the two parts are securely locked before letting go.

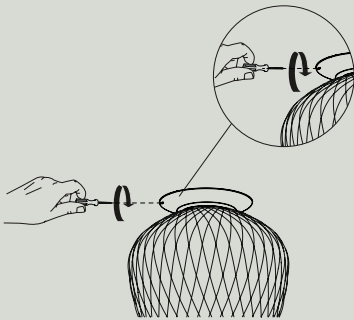
**Step 5**

Screw in the two set screws using the supplied hex screwdriver (C) to secure the installation. Make sure that the lamp is properly installed before installing the light source.

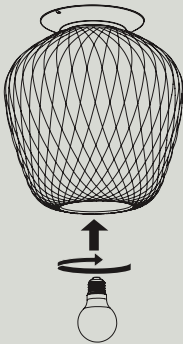
**Step 6**

Install the light bulb.